

HILTI

PS 200 S

English



1 Information about the documentation



1.1 About this documentation

- Read this documentation before initial operation or use. This is a prerequisite for safe, trouble-free handling and use of the product.
- Observe the safety instructions and warnings in this documentation and on the product.
- Always keep the operating instructions with the product and make sure that the operating instructions are with the product when it is given to other persons.

1.2 Explanation of symbols used



1.2.1 Warnings

Warnings alert persons to hazards that may occur when handling or using the product. The following signal words are used in combination with a symbol:

	DANGER! Draws attention to an imminent hazard that will lead to serious personal injury or fatality.
	WARNING! Draws attention to a potential hazard that could lead to serious personal injury or fatality.
	CAUTION! Draws attention to a potentially dangerous situation that could lead to minor personal injury or material damage.



1.2.2 Symbols in the documentation

The following symbols are used in this document:

	Read the operating instructions before use
	Instructions for use and other useful information

1.2.3 Symbols in the illustrations

The following symbols are used in illustrations:

	These numbers refer to the corresponding illustrations found at the beginning of these operating instructions.
3	The numbering reflects the sequence of operations shown in the illustrations and may deviate from the steps described in the text.
	Item reference numbers are used in the overview illustration and refer to the numbers used in the key in the product overview section.
	This symbol is intended to draw special attention to certain points when handling the product.

1.3 Product information

Hilti products are designed for professional use and may be operated, serviced and maintained only by trained, authorized personnel. This personnel must be informed of any particular hazards that may be encountered. The product and its ancillary equipment can present hazards if used incorrectly by untrained personnel or if used not in accordance with the intended use.

The type designation and serial number are stated on the rating plate.

- ▶ Write down the serial number in the table below. You will be required to state the product details when contacting Hilti Service or your local Hilti organization to inquire about the product.

Product information

Detector	PS 200 S
Generation	02
Serial no.	

2.1 General power tool safety warnings

WARNING

Read all safety warnings and all instructions. Failure to follow the warnings and instructions may result in electric shock, fire and/or serious injury.

Save all warnings and instructions for future reference.

Work area safety

- ▶ **Keep work area clean and well lit.** Cluttered or dark areas invite accidents.
- ▶ **Do not operate power tools in explosive atmospheres, such as in the presence of flammable liquids, gases or dust.** Power tools create sparks which may ignite the dust or fumes.
- ▶ **Keep children and bystanders away while operating a power tool.** Distractions can cause you to lose control.

Electrical safety

- ▶ **Power tool plugs must match the outlet. Never modify the plug in any way. Do not use any adapter plugs with earthed (grounded) power tools.** Unmodified plugs and matching outlets will reduce risk of electric shock.
- ▶ **Avoid body contact with earthed or grounded surfaces, such as pipes, radiators, ranges and refrigerators.** There is an increased risk of electric shock if your body is earthed or grounded.
- ▶ **Do not expose power tools to rain or wet conditions.** Water entering a power tool will increase the risk of electric shock.
- ▶ **Do not abuse the cord. Never use the cord for carrying, pulling or unplugging the power tool. Keep cord away from heat, oil, sharp edges or moving parts.** Damaged or entangled cords increase the risk of electric shock.
- ▶ **When operating a power tool outdoors, use an extension cord suitable for outdoor use.** Use of a cord suitable for outdoor use reduces the risk of electric shock.
- ▶ **If operating a power tool in a damp location is unavoidable, use a residual current device (RCD) protected supply.** Use of an RCD reduces the risk of electric shock.

Personal safety

- ▶ **Stay alert, watch what you are doing and use common sense when operating a power tool. Do not use a power tool while you are tired or under the influence of drugs, alcohol or medication.** A moment of inattention while operating power tools may result in serious personal injury.
- ▶ **Use personal protective equipment. Always wear eye protection.** Protective equipment such as dust mask, non-skid safety shoes, hard hat, or hearing protection used for appropriate conditions will reduce personal injuries.
- ▶ **Prevent unintentional starting. Ensure the switch is in the off-position before connecting to battery pack, picking up or carrying the tool.** Carrying power tools with your finger on the switch or energising power tools that have the switch on invites accidents.
- ▶ **Remove any adjusting key or wrench before turning the power tool on.** A wrench or a key left attached to a rotating part of the power tool may result in personal injury.
- ▶ **Do not overreach. Keep proper footing and balance at all times.** This enables better control of the power tool in unexpected situations.
- ▶ **Dress properly. Do not wear loose clothing or jewellery. Keep your hair, clothing and gloves away from moving parts.** Loose clothes, jewellery or long hair can be caught in moving parts.
- ▶ **If devices are provided for the connection of dust extraction and collection facilities, ensure these are connected and properly used.** Use of dust collection can reduce dust-related hazards.

Power tool use and care

- ▶ Do not force the power tool. Use the correct power tool for your application. The correct power tool will do the job better and safer at the rate for which it was designed.
- ▶ **Do not use the power tool if the switch does not turn it on and off.** Any power tool that cannot be controlled with the switch is dangerous and must be repaired.
- ▶ **Disconnect the battery pack from the power tool before making any adjustments, changing accessories, or storing power tools.** Such preventive safety measures reduce the risk of starting the power tool accidentally.
- ▶ **Store idle power tools out of the reach of children and do not allow persons unfamiliar with the power tool or these instructions to operate the power tool.** Power tools are dangerous in the hands of untrained users.

- ▶ **Maintain power tools. Check for misalignment or binding of moving parts, breakage of parts and any other condition that may affect the power tool's operation. If damaged, have the power tool repaired before use.** Many accidents are caused by poorly maintained power tools.
- ▶ **Keep cutting tools sharp and clean.** Properly maintained cutting tools with sharp cutting edges are less likely to bind and are easier to control.
- ▶ **Use the power tool, accessories and tool bits etc. in accordance with these instructions, taking into account the working conditions and the work to be performed.** Use of the power tool for operations different from those intended could result in a hazardous situation.

Battery tool use and care

- ▶ **Recharge only with the charger specified by the manufacturer.** A charger that is suitable for one type of battery pack may create a risk of fire when used with another battery pack.
- ▶ **Use power tools only with specifically designated battery packs.** Use of any other battery packs may create a risk of injury and fire.
- ▶ **When battery pack is not in use, keep it away from other metal objects, like paper clips, coins, keys, nails, screws or other small metal objects, that can make a connection from one terminal to another.** Shorting the battery terminals together may cause burns or a fire.
- ▶ **Under abusive conditions, liquid may be ejected from the battery; avoid contact. If contact accidentally occurs, flush with water. If liquid contacts eyes, additionally seek medical help.** Liquid ejected from the battery may cause irritation or burns.

Service

- ▶ **Have your power tool serviced by a qualified repair person using only identical replacement parts.** This will ensure that the safety of the power tool is maintained.

2.2 Careful handling and use of batteries

- ▶ Observe the special guidelines applicable to the transport, storage and use of lithium-ion batteries.
- ▶ Do not expose batteries to high temperatures, direct sunlight or fire.
- ▶ Do not take apart, squash or incinerate batteries and do not subject them to temperatures over 80 °C.
- ▶ Do not attempt to charge or continue to use damaged batteries.
- ▶ If the battery is too hot to touch, it may be defective. In this case, place the power tool in a non-flammable location, well away from flammable materials, where it can be kept under observation and left to cool down. Contact **Hilti** Service after the battery has cooled down.

3 Description

3.1 Overview

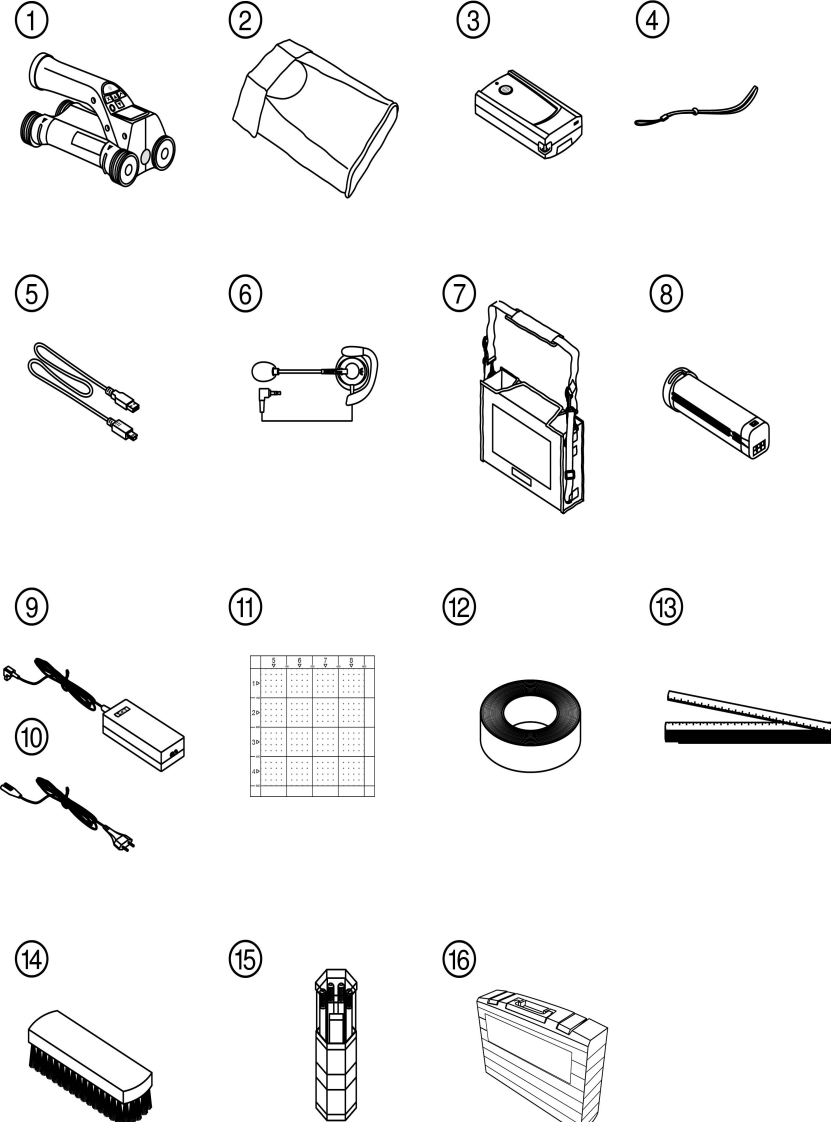

① PS 200 S scanner

② PSA 60 soft pouch

③ PSA 55 infrared adapter

④ PSA 63 hand strap

⑤ PSA 92 USB data cable

⑥ PSA 93 headset / microphone

⑦ PSA 64 soft pouch

⑧ PSA 80 battery

⑨ PUA 81 AC adapter

⑩ PUA 80 charger

⑪ PSA 10/11 reference grid set

⑫ PUA 90 adhesive tape

⑬ Folding rule

⑭ PSA 70 brush

3.2 Intended use

The product is designed to be used for locating reinforcing bars in concrete, measuring depth of concrete cover and estimating the diameter of the bars in the uppermost layer in accordance with the specifications detailed in the technical data provided in these operating instructions.

3.3 Applications

The product can be used for various non-destructive detection applications on steel-reinforced concrete structures (e.g. locating reinforcing bars in the uppermost layers, measuring depth of concrete cover and estimating the diameter of the bars detected). The scanning mode used depends on the application. These fall broadly into the following categories:

Situations and scanning modes

Situation	Scanning mode
Avoiding damage to reinforcing bars when drilling or core drilling	Quickscan detection, Imagescan or Blockscan
Determining the position / number and diameter of bars for loadbearing capacity checks or depth-of-cover measurements	Imagescan
Large-area scan to determine depth of concrete cover	Quickscan recording

For reliable scanning results, the following conditions must be fulfilled

- Concrete surface smooth and flat.
- Reinforcement not corroded.
- Reinforcement lies parallel to concrete surface.
- Concrete does not contain additives or constituents with magnetic properties.
- Reinforcing bars lie within $\pm 5^\circ$ of right angle to the scanning direction.
- Reinforcing bars are not welded.
- Neighboring bars are of similar diameter.
- Neighboring bars are at a similar depth.
- Accuracy specifications are valid only for the first layer of reinforcement.
- No interfering influences from external magnetic fields or objects nearby with magnetic properties.
- Bars have relative magnetic permeability of 85–105.
- The scanner wheels are clean and free from sand and grit etc.
- All 4 scanner wheels are in contact and rotate when the scanner is moved across the object to be scanned.

3.4 Working principle

The scanner is moved directly over the concrete surface. The data collected is stored in the scanner until it can be transferred to the tablet. The tablet is used for storing large amounts of data and for viewing the scans. It can also be used for on-the-spot evaluation of scans. The data can also be downloaded to a PC. The PC software offers advanced analysis options, data archiving functions and the ability to quickly print out complete reports for documentation purposes.

3.5 Using the system

The scanner can be used without the tablet (for scanning only). The tablet can be carried in the PSA 64 soft pouch. The first option is advantageous when working in areas that are difficult to access and maximum mobility is required, such as on a scaffold or ladder. When scanner memory is full (9 Imagescans made, 1 complete Blockscan or 30 m of Quickscan have been recorded) the data can be transferred to the PSA 55 infrared adapter or to the tablet. The tablet can be kept nearby (e.g. at the foot of the scaffold, in a vehicle, in the site office etc.). When the user intends to make more scans than the scanner is capable of storing in its memory and wishes to avoid repeated journeys to the tablet, the PSA 55 infrared adapter can be used or the tablet attached to a belt or carried using the shoulder strap supplied.

3.6 Quickscan detection

The scanner is moved across the surface at right angles to the reinforcing bars. The position and approximate depth of the reinforcing bars can be determined and marked right away on the surface of the concrete.

3.7 Quickscan detection with accurate depth measurement

Before scanning, the operator is required to enter values for the diameter of the reinforcing bars and the spacing between the bars. The scan is then carried out as described for Quickscan detection.

3.8 Quickscan recording

Data is recorded automatically as the scanner is moved over the surface. This data is subsequently transferred to the tablet where it can be evaluated and the average depth of cover determined. If the data is downloaded to a PC, the information can be evaluated, archived and a report printed. Further evaluation options allow Quickscan recordings to be imported and evaluated automatically, statistical evaluations prepared and scans displayed in the form of large-area evaluations.

3.9 Imagescan

A reference grid is attached to the area to be scanned using the adhesive tape supplied. After selecting the Imagescan mode with the scanner, the rows and columns of the grid are scanned following the instructions on the screen. The data is transferred to the tablet where the image can be viewed. The position of the reinforcing bars relative to the concrete surface is indicated. Bar diameter can be estimated and bar depth determined. If the data is downloaded to the PC application, this information can be evaluated as on the tablet, with the additional advantage of allowing a series of points to be recorded along with associated depth and diameter, and the data saved for future use. Reports can be printed. Further evaluation options allow Imagescans to be imported and evaluated automatically, statistical evaluations prepared and scans displayed in the form of large-area evaluations.

3.10 Blockscan

A reference grid is attached with adhesive tape to the area to be scanned. After selecting Blockscan mode, the user is prompted to select the first area to scan. An Imagescan is then made. After completing the Imagescan, the user is prompted to select the next area to scan. This should be adjacent to the previous area. Attach the grid and then scan as before. This procedure can be repeated for up to 3 x 3 Imagescans. The data is transferred to the tablet. The Imagescans are automatically stitched together to form a larger image. The reinforcement layout can then be viewed over the whole area. Individual Imagescans can be selected for evaluation by zooming in. If the data is downloaded to the PC application, this information can be evaluated as on the tablet, with the additional advantage of allowing a series of points to be recorded along with associated depth and diameter, and the data saved for future use. A report can be printed.

4 Technical data

4.1 PS 200 S technical data

Maximum scanning speed	0.5 m/s (1.6 ft/s)
Memory type	Built-in data flash memory
Memory capacity	9 Imagescans plus up to 30 m of Quickscan recording (max. 10 scans)
Screen type / size	LCD / 50 × 37 mm (1.97" x 1.46")
Display resolution	128 x 64 pixels
Dimensions	10.2" x 5.2" x 5.2"
Weight (with PSA 80 battery)	1.4 kg (3.1 lb)
Minimum battery life with PSA 80 battery	8 hours under typical conditions
Automatic power-off	5 minutes after the last time a button is pressed
Backup battery type / life	Lithium / 10 years (typically)
Data interface between the scanner and tablet	Infrared

Data transfer time between scanner and tablet	≤16 s for 9 images, ≤2 s for 1 image
Infrared range	Typically 0.3 m (0.98 ft)
Infrared output power	Max. 500 mW

4.2 Ambient conditions

	PS 200 S
Operating temperature	-10 °C ... 50 °C (14 °F ... 122 °F)
Storage temperature	-20 °C ... 60 °C (-4 °F ... 140 °F)
Dust and water protection (operation)	IP54
Impact resistance (device in toolbox)	EN 60068-2-29
Dropping	EN 60068-2-32
Vibration (not in operation)	MIL-STD 810 D

4.3 Technical data for PSA 55 infrared adapter

Battery	1 x 1.5 V AAA
Dimensions	3.54" x 1.9" x 1.1"
Weight	65 g (2.3 oz)
Data interface between the scanner and tablet	Infrared
Adapter - computer data interface	USB

5 Operation

5.1 Inserting the battery



Note

The temperature inside a motor vehicle exposed to the heat of the sun can easily exceed the maximum permissible storage temperature for the PS 250 Ferrosan system. Some of the components of the PS 250 Ferrosan system may suffer damage if exposed to temperatures exceeding 60°C.

- Insert the battery.

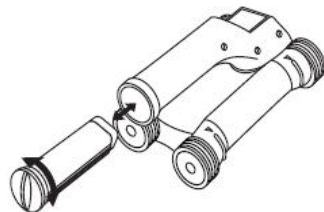

5.2 Main menu

The system always starts in the main menu. All scanning functions and set-up options are selected here. The battery state of charge is displayed at the top of the screen together with the memory status. The various scan modes and settings menus are displayed as symbols on the left side of the screen. Use the arrow buttons to toggle between these options. The Confirm button selects the option.

5.2.1 Quickscan

The remaining memory for Quickscan recording is shown at the top of the screen in meters or feet (depending on the scanner type and units set).

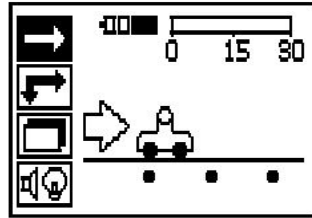

5.2.2 Imagescan

The number of Imagescans in the scanner, up to a maximum of 9, is shown at the top of the screen.

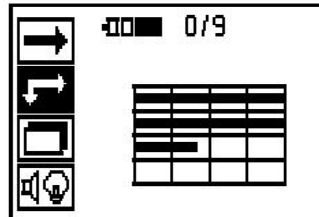

5.2.3 Blockscan

The number of Imagescans in the scanner, up to a maximum of 9, is shown at the top of the screen.

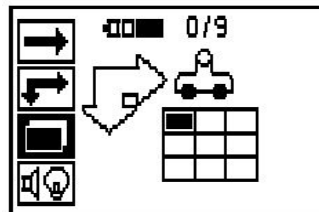

5.2.4 Settings

Sets various parameters and deletes all scans held in memory.

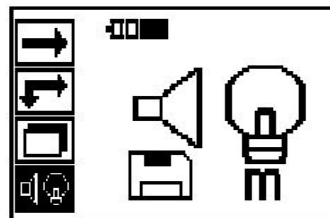

5.3 Set display backlight

Select the backlight adjustment function by pressing the Confirm button. Use the arrow buttons to toggle between the individual options. Press Confirm to select the desired option and press Cancel to return to the settings menu.

Backlight permanently on

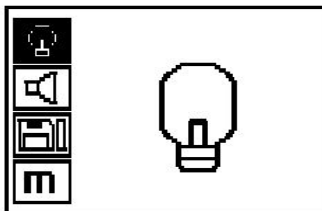

Backlight permanently off

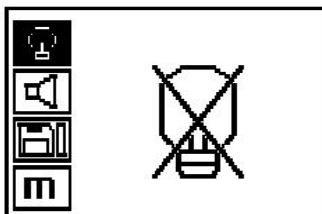

Backlight is controlled automatically. With this option, the backlight is switched off automatically after 5 minutes if no button is pressed during this time and is reactivated the next time a button is pressed.

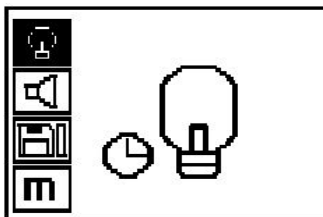

5.4 Adjusting the volume

Sets the volume level of the audible signal during scanning. Use the arrow buttons to toggle between options, Press the Confirm button to select the desired option and press the Cancel button to return to the settings menu.

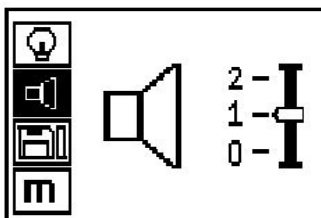

5.5 Setting the unit of measure

On certain models, the unit of measure used for scanning can be set to an alternative system. Use the arrow buttons to toggle between options, Press the Confirm button to select the desired option and press the Cancel button to return to the settings menu.

metric (mm or m, as appropriate)

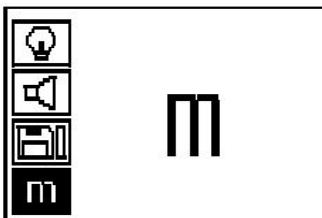

imperial (feet, where applicable)

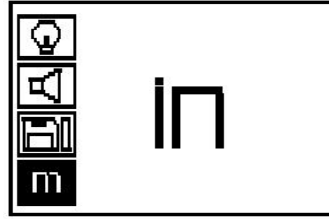

5.6 Deleting data

Press the Down arrow button followed by the Confirm button to delete data. Alternatively, press the Cancel button to return to the settings menu.

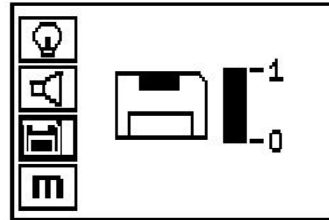

Note

Deleting memory contents presents a risk of data loss. Data that has not been transferred to the tablet before deletion will be permanently lost.

Deletes all scan data stored in the scanner. This function is available only if data is contained in memory. If data is contained in memory, the bar shown next to the diskette symbol is filled. The bar is shown unfilled when no data is contained in memory.

5.7 Quickscan

Quickscan can be used to quickly detect the positions and approximate depths of reinforcing bars, which can then be marked on the surface. This procedure is known as Quickscan detection. Another function in Quickscan mode is accurate depth measurement, which requires that values for bar diameter and bar spacing are previously entered. Alternatively, the data can be recorded and evaluated on the tablet or using the PC application. The average depth of cover over the reinforcement over large stretches of the surface can thus be easily determined. This is known as Quickscan recording.

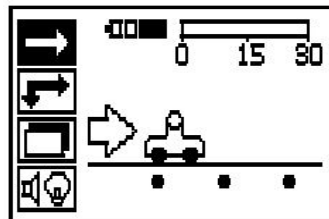

Note

The scanner detects only reinforcing bars that lie at right angles to the direction of travel. Bars that lie parallel to the direction of travel will not be detected. Make sure that the object is scanned in both the horizontal and vertical directions. An incorrect depth may be calculated for bars that lie diagonal to the direction of travel.

Switch on the scanner. The Quickscan symbol is selected first automatically. Use the Confirm button to select the Quickscan function from the main menu.

1. Bar depth
2. Distance traveled
3. Signal strength
4. Settings: Minimum depth, scanning direction, bar diameter, bar spacing

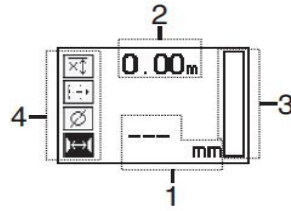

5.8 Quickscan detection

Move the scanner over the surface. Reinforcing bars that lie at right angles to the direction of travel will be detected. The distance covered by the scanner is recorded.

Signal strength indicated by the column in the display increases as the scanner approaches a bar and the depth value is also shown. When the scanner is positioned over the center of a reinforcing bar:

- The red LED lights.
- A signal tone is emitted.
- Maximum signal strength is indicated.
- The approximate depth of the bar is indicated (lowest depth value indicated = center of the bar).

The bar is positioned along the center line of the scanner and may be marked on the surface using a PUA 70 marker. Depth measurement accuracy can be increased by entering the correct rebar diameter or by switching to accurate depth measurement mode.

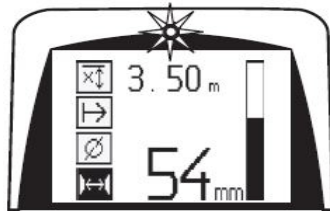

5.9 Quickscan with accurate depth measurement

The measuring mode "Quickscan with accurate depth measurement" is selected by pressing the Confirm button.



The correct diameter must be known and previously entered. The bar spacing distance must also be entered if within the $36 \text{ mm} \leq s \leq 120 \text{ mm}$ ($1.41" \leq s \leq 4.72"$) range. This value can be taken from building plans, confirmed by chipping away a channel in the concrete to view the bars, or measured using Quickscan detection.



Note

A rebar spacing distance $s \leq 36 \text{ mm}$ ($1.41"$) cannot be measured.

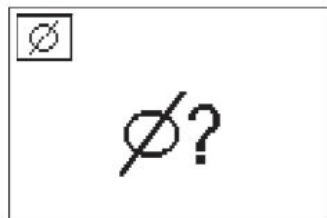

The bar spacing distance can be calculated automatically using the Quickscan detection function by searching for the center of the bar and pressing the red Record button when the scanner is over the mid point of the bar. Next, search for the mid point of the next bar and again press the Record button. Bar spacing is then calculated automatically and recorded.



If the spacing distance is known, the value can also be entered manually using the arrow buttons.



After setting the bar diameter and the spacing distance, the procedure is exactly the same as for Quickscan detection.



5.10 Quickscan recording



Note

Before making a Quickscan recording, always make an Imagescan or a Quickscan detection scan in both directions in order to determine the orientation of the rebars in the top layer, to minimize the risk of scanning rebar lap joints and, where applicable, to immediately see whether the concrete contains ferrous materials that could have a detrimental effect on the accuracy of the scans.



Note

Reinforcing bars that lie at right angles to the direction of travel will be detected and automatically recorded. Check to ensure that the settings are correct before beginning recording.

Do not press the Record button before placing the scanner at the point where the scan should begin. The scan should not, under any circumstances, be started or stopped while the scanner is directly over a bar. Keep an eye on the display (observe a distance of at least 30 mm (1.81") to the nearest reinforcing bar). Failure to do this may result in incorrect or misleading measurements.



Note

Do not lift the scanner from the surface before stopping the recording or setting a marker.

To record the position and depth of all reinforcing bars detected, place the scanner on the surface and use Quickscan detection to find a position where there are no bars present. Mark the starting point with a PUA 70 marker and press the Record button. The diskette symbol appears on the screen, indicating that the scanner is recording data. Move the scanner over the surface.

At the end of the scan, take care to ensure that the end point is not directly over a rebar. To stop recording, press Record again. Use a PUA 70 marking pen to mark the end of the stretch that has been scanned.

A stretch of up to 30 m (98 ft) in length can be recorded before it is necessary to transfer the data to the tablet or the PSA 55 infrared adapter. It is also possible to record several separate stretches (max. 10) that add up to a maximum of 30 m (98 ft).

The data recorded can be transferred to the tablet for analysis.

5.11 Quickscan settings

The Quickscan settings are shown on the left-hand side of the display. The settings can be made before making a Quickscan or a Quickscan with accurate depth measurement. Use the arrow buttons and Confirm button to access the settings.

Limited depth scan



Note

This measurement mode allows rebars to be located within a specified depth range.



Note

When using the device in this mode, the preset depth must take a clearance distance from the rebar into account.

Minimum depth

Use this setting when scanning a surface and looking specifically for bars that are located within a certain depth. For example, if checking for 40 mm minimum depth of cover, set the value to 40 mm (1.57") (for quality assurance measurements add an extra 2 mm (0.08") to account for any accuracy limitations). A signal tone is emitted and the LED lights only if a reinforcing bar located within 40 mm (1.57") of the surface is detected.

Use the arrow buttons to select the minimum depth function and then press Confirm.



Minimum depth function disabled

When the value is set to "0", the function is deactivated and appears as above. Use the arrow buttons to enter the desired depth value and then confirm the setting by pressing the Confirm button. The system returns to the main menu.

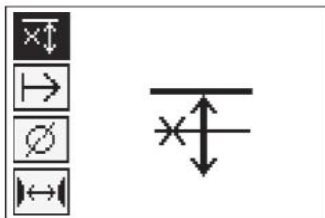

Note

If reinforcing bars are located at depths greater than the minimum depth set, no signal tone is emitted and no LED lights.

Scan direction

This setting is used to set the direction in which Quickscan recording is performed. Although they have no direct effect on any measurement values later obtained from the tablet or PC application, the settings help to ensure that individual Quickscan recordings are subsequently correctly displayed in **Hilti** PROFIS Ferroscan MAP (data evaluation and presentation application) and that the depth values correspond with the actual surface of the structure. This makes it easier to subsequently locate the positions of areas with inadequate cover. The scanning direction is saved together with each scan.

Select the desired scanning direction and press the Confirm button.

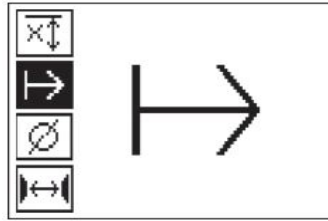

Bar diameter

This setting must be made in order to obtain an accurate depth-of-cover measurement (= rebar depth). Depth can be measured accurately only when correct rebar diameter has been entered.

Use the arrow buttons to select the bar diameter function and then press the Confirm button.

If no bar diameter is selected, the scanner will calculate the depth as though the average bar diameter of the relevant standard setting range were set.

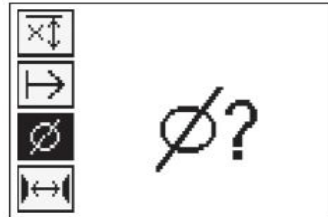

5.12 Setting a marker

The surfaces of many structures contain obstacles that make it impossible to record the scan without lifting the scanner from the surface. Examples of such obstacles are piers or columns on a wall, door openings, expansion joints, pipes, scaffold bars, corners etc.

If an obstacle is encountered, a marker can be set. This interrupts the scan and allows the user to lift the scanner away from the surface, place it beyond the obstruction and then continue scanning. It also indicates where certain objects are located within a scan, providing additional information that creates a reference between the scan data and the actual surface.

To set the marker press and hold Confirm whilst in recording mode. The diskette symbol will be crossed out, indicating that recording has been suspended and a marker has been set.

Then lift the scanner from the surface while keeping the Confirm button pressed. If necessary, mark the position on the surface using a PUA 70 marker. Place the scanner back on the surface beyond the obstacle, release the Confirm button and continue scanning. The marker will be shown as a vertical line in the scan data when viewed on the tablet or in the **Hilti PROFIS Detection** PC application.



5.13 Imagescan

Imagescan is used to create an image of the reinforcement layout. The depth and diameter of the bars can be determined or, respectively, estimated. A reference grid must first be attached to the wall. Use the adhesive tape supplied for this purpose. This tape is designed specifically for sticking to concrete structures and can be torn off the roll by hand at the correct length. For most surfaces, a 10 cm (3.94") length of tape at each corner is adequate to secure the grid. If the concrete surface is very damp or dusty, use the brush supplied to clean off any dirt and dust. The reference grid may then have to be attached by applying a strip of tape along the full length of each edge.

Alternatively, a grid can be marked directly on the surface. Using a straight edge (such as a piece of wood) as a guide, mark out a 4 x 4 grid with the parallel lines spaced at intervals of 150 mm (5.9"). The holes punched in the paper reference grid can also be used to mark the positions of the grid lines on the concrete surface. Switch the scanner on and select the Imagescan symbol. The battery state of charge is displayed together with the number of Imagescans currently held in memory (a maximum of 9).

Select Imagescan from the main menu. The Imagescan screen is displayed.

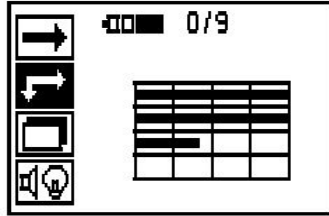

A representation of the grid appears on the screen with a suggested starting point (triangle). This is always at upper left and will be suitable for most scans. Image data will be generated only for areas of the grid that have been scanned both vertically and horizontally. In some cases, obstacles in the scan area may prevent this (e.g. a pipe penetrating a beam). The starting point may be changed in such cases in order to allow the area to be scanned optimally. Use the Arrow buttons to change the starting point.

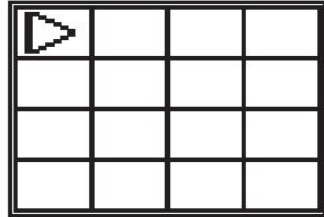

Place the scanner on the grid at the starting point shown by the flashing arrow. Ensure the alignment marks on the scanner are aligned correctly with the reference grid as shown above.



Note

Incorrect alignment of the scanner on the reference grid may lead to the bar positions being incorrect in the image generated.

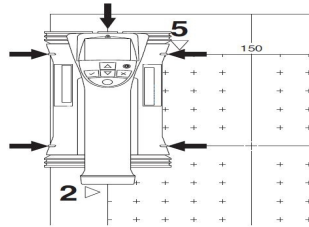

Press Record and move the scanner along the first row. Scanning progress is indicated by a thick black line that advances across the display as the scanner is moved over the surface.

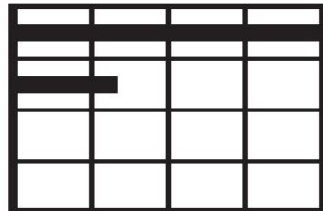

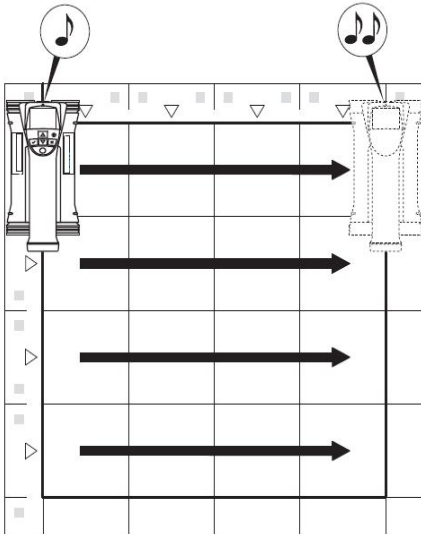

The scanner emits a double beep at the end of the row and automatically stops recording. This procedure should be repeated for each row and column while observing the instructions shown in the display.

When all rows have been completed, the columns should also be scanned in the same way.

The recording of any row or column may be interrupted before reaching the end by pressing Record again. This may be necessary if an obstacle prevents the full path being scanned. Similarly, an entire row or column may be skipped by starting and stopping the recording without running the scanner over the grid. Please note that no image will be created for areas of the reference grid that are not scanned in both directions.

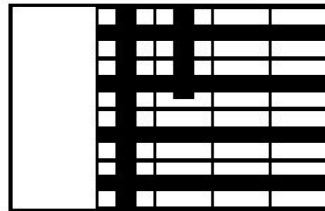

It is possible to repeat the previous row or column by pressing Cancel. This may be necessary if the user is not sure whether the path to be scanned has been followed accurately or if the scanner slipped out of position. Pressing Cancel a second time aborts the scan and the system then returns to the main menu. Press Confirm to save the scan. Pressing Cancel after scanning the last column or row will cause the scan to be deleted.

When the scan is complete, press the Confirm button to return to the main menu. The data may be transferred to the tablet for viewing and evaluation.

5.14 Blockscan

Blockscan automatically stitches Imagescans together to give an impression of the reinforcement layout over a large area. The exact bar position, depth and diameter can also be determined on the tablet by selecting each Imagescan individually.

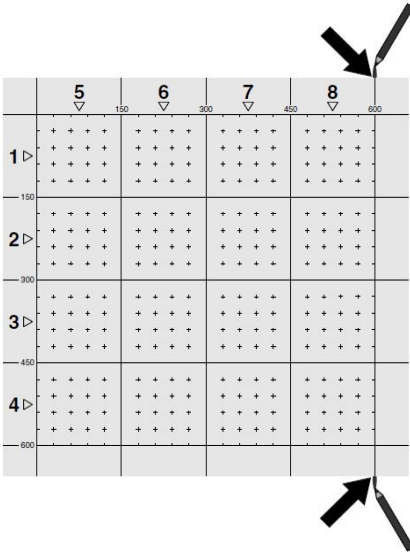

Attach the reference grid in the same way as for an Imagescan. Use a PUA 70 marking pen to mark the edges or the punched holes at the end of each reference grid for the transition to the next grid, as shown below. Any additional reference grids required should be attached to the wall so that their edges correspond and are in alignment with each other.

Switch the scanner on and use the arrow buttons to select the Blockscan symbol from the main menu. The battery state of charge is indicated, together with the number of Imagescans currently held in the memory out of a maximum of 9.

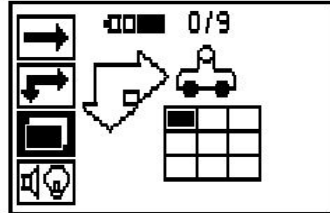

A representation of a Blockscan is shown on the screen. Each square represents an Imagescan. Up to 3 x 3 Imagescans can be made. Select the position of the first Imagescan that you will make in the series using the arrow buttons. Press Confirm to begin the first Imagescan. Note that the coordinates of any points on the Blockscan will be referenced from the upper left corner.

For details of how to make an Imagescan, please refer to 6.13. When the Imagescan is complete, the system returns to the Blockscan screen.

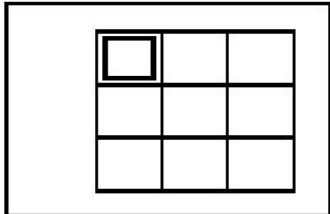

The completed Imagescan is shown shaded.

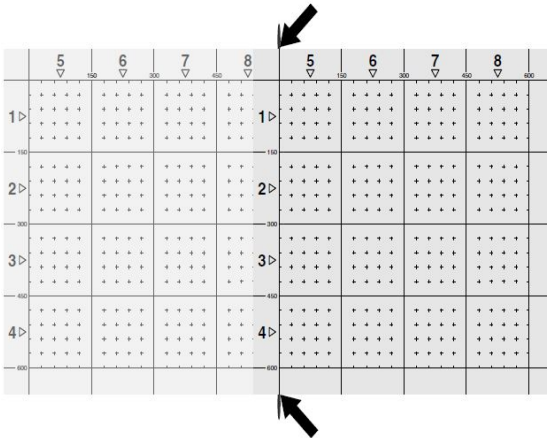
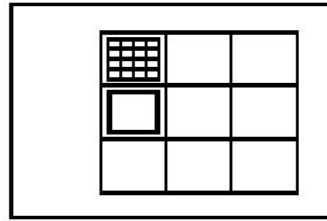

Select the next Imagescan position and repeat the scanning procedure. Imagescans already made may be repeated simply by reselecting the area to scan and carrying out the Imagescan again. The data will be overwritten. Once all the Imagescans have been recorded, or the maximum number of scans that can be held in memory is reached (9), press the Cancel button to return to the main menu. For visualization and analysis, the data is transferred to the tablet.



Note

Pressing the Cancel button twice causes the recorded Imagescan to be deleted. The screen then returns to the main menu.

5.15 PSA 55 infrared adapter

5.15.1 Before first use



Note

Install the **Hilti** PROFIS Detection PC application on your PC or laptop. The date and time must be set before using the PSA 55 IR adapter for the first time in order to ensure that the scan data subsequently shows the correct date and time.

- To do this, use the PUA 95 Micro USB cable to connect the PSA 55 IR adapter to the computer.
- Open the **Hilti** PROFIS Detection PC application.
- Go to "Tools", "Workflow" and then select "Set PSA 55 date and time". The date and time are then set in the PSA 55 IR adapter.



Note

The device driver will be installed together with **Hilti** PROFIS Detection. If this is not the case, the device driver must be installed manually by running the "setup.exe" file located in the "Drivers" folder on the PSA 55 IR adapter.

5.15.2 Operating the PSA 55 infrared adapter

The scans can be transferred to the adapter via the infrared interface and from there to the PC or laptop. Switch the adapter on or off by pressing the on / off button for about 3 seconds.

The LED display on the adapter can indicate the following statuses:

- The green LED lights constantly: The adapter is switched on and is ready for operation.
- The red LED flashes rapidly: Battery state of charge is low.
- The green LED flashes: The adapter has just been switched on.
- The green LED flashes: Data transfer in progress.
- The red LED flashes and the adapter switches itself off: Memory is 95% full.

5.16 Data transfer

5.16.1 Data transfer between the scanner and tablet

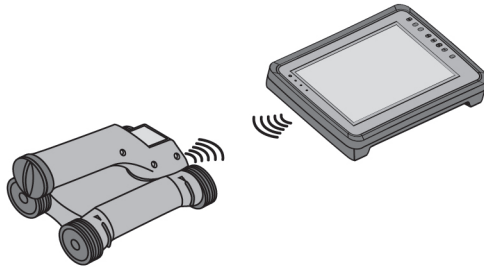

Note

Ensure that the correct project is selected on the tablet before transferring data.



Note

Check that the windows at the infrared ports are free from dirt, dust and grease and are not excessively scratched before commencing data transfer. Failure to do so may result in reduced data transfer range or may prevent data transfer.

Data is transferred from the scanner to the tablet using the infrared connection. The infrared windows are situated at the ends of scanner and the tablet.

Data can be transferred at any time when the scanner and tablet are switched on, the PS 200 S scanner is displaying the main menu and infrared data transfer is activated on the tablet. On the tablet under "Project", select the project into which the data is to be copied. Then select "Import" and "From PS 200 S" and confirm by pressing the OK button. The infrared symbol then appears in the status area of the tablet.

Bring the scanner and tablet close together so that the infrared windows are facing each other. The scanner and tablet recognize each other automatically and establish a connection.

This screen appears on the scanner and a beep sounds:

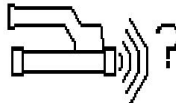

Press the Confirm button on the scanner to begin importing all scan data into the selected project.

This screen appears on the scanner while data transfer is in progress and the red LED on the scanner flashes continuously.

Data transfer takes between 1 and 15 seconds, depending on the number and length of scans contained in the scanner.

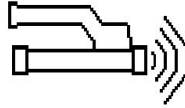

This screen is displayed by the scanner when data transfer is complete:

Press the Confirm button on the scanner again to end the data transfer procedure. The scan data in the scanner is then deleted automatically.

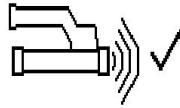

5.16.2 Data transfer between the scanner and the adapter



Note

Use the adapter only indoors. Avoid moisture ingress.



Note

Ensure that the windows at the infrared ports are free from dirt, dust and grease and are not excessively scratched before commencing data transfer. Failure to do so may result in reduced transfer range or may prevent the data being transferred.

Data is transferred from the scanner to the adapter using the infrared connection. The infrared windows are situated at the ends of scanner and the adapter.



Note

The maximum range of the infrared connection is approximately 30 cm (12 inches). The maximum permissible angle between the scanner and adapter for successful data transmission at close ranges (up to 10 cm (3.94")) is $\pm 50^\circ$ relative to the axis of the infrared port on the adapter. At a distance of 15 cm this angle is reduced to $\pm 30^\circ$. At a distance of 30 cm (11.81") the scanner must be accurately aligned with the adapter to ensure successful data transmission. Scans can be transferred at any time when the scanner and adapter are switched on and the scanner is displaying the main menu.

Bring the scanner and adapter close together so that the infrared windows are facing each other. The two devices recognize each other automatically and establish a connection. The following screen appears on the scanner and a beep sounds:

Press the Confirm button on the scanner to begin data transfer. The following may be observed while data transfer is in progress:

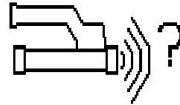

The green LED on the adapter flashes rapidly to indicate that data transfer is in progress. The red LED on the scanner flashes continuously:



This screen is displayed by the scanner when data transfer is complete:

All scan data has then been successfully transferred. Press the Confirm button on the scanner again to end the data transfer procedure. The scan data has been successfully transferred.

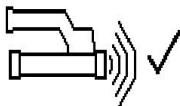

The scans are numbered by the adapter.

5.16.3 Transferring data from the adapter to the computer



Note

To ensure data security, data integrity and to avoid malfunctions, use only the PUA 95 Micro USB cable supplied by Hilti.

The PUA 95 Micro USB data cable is used to transfer data from the adapter to the computer. The adapter can be removed once data transfer is complete.



Note

In order to remove the PSA 55 adapter safely, we recommend use of the “Remove hardware safely” function of the operating system. This helps prevent loss of data integrity.

5.16.4 Transferring data from the tablet to the computer



Note

To ensure data security, data integrity and to avoid malfunctions, use only the PSA 92 Micro USB cable supplied by Hilti.

The PSA 92 USB data cable is used to transfer data from the tablet to the computer.

5.16.5 Tips for scanning and evaluation

The object is too narrow to scan or reinforcement is too close to an outside edge to be scanned properly

Use a thin sheet of non-metallic material (e.g. cardboard, wood, polystyrene foam, etc.) as an overlay that extends beyond the edge. The scanner can then be moved over the sheet to beyond the edge of the structure. Note that the thickness of the overlay sheet must be deducted from any depth measurements. The thickness of the overlay sheet can be entered in the PC application. This value will then be automatically deducted from any depth measurements.

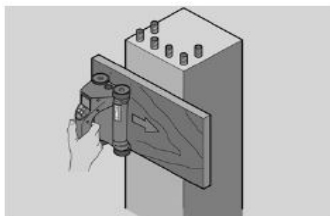

The surface is rough.

Rough surfaces (e.g. concrete surfaces with exposed aggregates) cause additional noise in the signal and may mean that the depth or diameter of a bar cannot be determined. In such cases it is also advantageous to scan through a thin overlay sheet. Also in this case, the thickness of the overlay sheet must be deducted from any depth measurements.

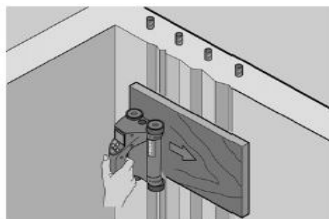

“Interference” in images

Interference in images may occur due to:

- Scraps of reinforcement in the concrete
- Tie wires where rebars cross
- Aggregates with ferromagnetic properties
- Ends of bars lying parallel to the scanning plane
- Ends of bars lying at right angles to the scanning plane (standing bars)

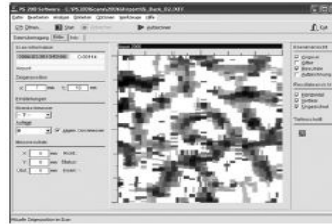

Note

Diameters and depths calculated in the area where interference occurs must be treated with caution as they may be inaccurate.

Scanning columns and beams for making penetrations

In such cases where the reinforcement must not be damaged, ensure that Imagescans are made on at least three sides of the component in order to ensure that shear bars (placed at an angle in the concrete) can also be identified.

Simple diameter check

A simple, rough check of the diameter of the bars in the first layer can be made by deducting the depth of the second perpendicular layer from that of the first. This assumes however that the two layers touch each other or are at least very close.

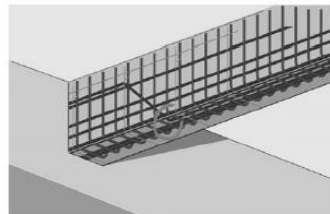

5.16.6 PC software



The **Hilti PROFIS Detection** PC application provides functions for enhanced analysis, easy creation of reports, data archival, image and data export to other PC applications as well as automated batch processing of large volumes of data.





Die **Hilti PROFIS Detection MAP** PC application makes it possible to assemble large volumes of data as a large-area image or evaluation scan with an area of up to 45x45 m.





Detailed information about using the PC applications can be found in the Help menu.

6 Troubleshooting

6.1 Troubleshooting

Malfunction	Possible cause	Action to be taken
 <p>The scanner doesn't record during Quickscan detection.</p>	<p>The maximum scanning speed of 0.5 m/s was exceeded.</p>	<p>▶ Press the Confirm button and repeat the scan. Move the scanner over the surface more slowly.</p>
 <p>The scanner doesn't record while making a Quickscan recording.</p>	<p>The maximum scanning speed of 0.5 m/s was exceeded.</p>	<p>▶ Press the Confirm button. Repeat the scanning operation from the starting point or from the last point at which a marker was set. Move the scanner over the surface more slowly.</p>

Malfunction	Possible cause	Action to be taken
 <p>The scanner doesn't record while making an Imagescan.</p>	<p>The maximum scanning speed of 0.5 m/s was exceeded.</p>	<ul style="list-style-type: none"> ▶ Press the Confirm button. Scan the row or column again. Move the scanner over the surface more slowly.
 <p>The scanner doesn't record.</p>	<p>This symbol may appear if the scanner is moved in the wrong direction when in Quicksan recording mode, i.e. you begin scanning, for example, from right to left but at some point during the Quicksan recording you move the scanner to the right.</p>	<ul style="list-style-type: none"> ▶ Press the Confirm button and repeat the scan. Move the scanner in the correct direction. ▶ NOTE The warning does not appear immediately, but only when the scanner is moved 15 cm or more in the wrong direction.
 <p>The data is not transferred between the scanner and the tablet.</p>	<p>Data transfer was interrupted or a connection could not be established.</p>	<ul style="list-style-type: none"> ▶ Check that the scanner and tablet are positioned within maximum range (30 cm) and that they are correctly aligned with each other. ▶ Check that the PSA 56 infrared adapter is plugged in correctly. ▶ Make sure that the atmosphere is as dust-free as possible and that the infrared windows on both scanner and tablet are clean and not badly scratched. Badly scratched infrared windows must be replaced by Hilti Service. ▶ Try to hold the tablet and scanner steady and in correct alignment with each other until data transfer is completed. ▶ Try to hold the tablet and scanner steady and in correct alignment with each other until data transfer is completed.
 <p>The data is not transferred between the scanner and the tablet.</p>	<p>Indicates that the scanner or tablet may be defective.</p>	<ul style="list-style-type: none"> ▶ Remedy the problem by switching the units off and on or adjusting their alignment with each other. ▶ NOTE Data will not be lost in the event of an interruption during data transfer. Data is deleted from the scanner only once all scan data has been correctly transferred and the Confirm button on the scanner is pressed. If the error message reappears, the appliance will need to be sent to Hilti for repair.
 <p>The data is not transferred between the scanner and the PSA 55 adapter.</p>	<p>Indicates that the scanner or adapter may be defective.</p>	<ul style="list-style-type: none"> ▶ Remedy the problem by switching the unit off and on or adjusting its alignment.

Malfunction	Possible cause	Action to be taken
 <p>The data is not transferred between the scanner and the PSA 56 adapter.</p>	Indicates that the scanner or adapter may be defective.	<ul style="list-style-type: none"> ► Remedy the problem by switching the unit off and on or adjusting its alignment.
 <p>This symbol indicates a critical error in the scanner and may appear immediately after switching on.</p>	They indicate a possible electronic fault.	<ul style="list-style-type: none"> ► Switch the scanner off and then back on again. If the error message appears again, the appliance will need to be sent to Hilti for repair.
 <p>This symbol indicates a critical error in the scanner and may appear immediately after switching on.</p>	They indicate a possible electronic fault.	<ul style="list-style-type: none"> ► Switch the scanner off and then back on again. If the error message appears again, the appliance will need to be sent to Hilti for repair.
 <p>This symbol indicates an operator error and may appear when starting various scanning activities.</p>	This indicates that the memory allocated to the operation is full and that no more data can be stored.	<ul style="list-style-type: none"> ► In this situation, the data must either be transferred to the tablet or deleted from scanner memory. ► CAUTION Deleting the contents of scanner memory may result in data loss. Data that has not been transferred to the tablet before deletion will be permanently lost.

6.2 Troubleshooting

If the trouble you are experiencing is not listed in this table or you are unable to remedy the problem by yourself, please contact **Hilti** Service.

Trouble or fault	Possible cause	Action to be taken
The scanner doesn't start.	The battery is not charged.	► Change the battery.
	The contacts on the battery or in the scanner are dirty.	► Clean the contacts.
	The battery is old or defective, or the maximum number of charging cycles has been exceeded.	► Contact Hilti Service.
The scanner doesn't run freely.	The wheels are dirty or dusty.	► Remove the wheels and casing and clean the parts.
	The drive belt or gear teeth are worn.	► Contact Hilti Service.
The scanner may be operated only for a short time before the battery is exhausted.	The battery is old or defective, or the maximum number of charging cycles has been exceeded.	► Contact Hilti Service.
The scan date and time are not correct.	The date has not yet been set with the Hilti PROFIS Detection PC application.	<ul style="list-style-type: none"> ► Install Hilti PROFIS Detection and start the application. ► Connect the PSA 55 IR with the data cable and set the date and time.

7 Transport and storage of cordless tools

Transport



CAUTION

Inadvertent starting during transport. Uncontrolled starting during transport may occur if the battery is fitted, thereby resulting in damage to the tool.

- ▶ Always remove the battery before transporting the tool.

- ▶ Remove the battery.
- ▶ Transport the tool and batteries individually packaged.
- ▶ Never transport batteries in bulk form (loose, unprotected).
- ▶ Check the tool and batteries for damage before use after long periods of transport.

Storage



CAUTION

Inadvertent damage caused by defective battery. A leaking battery may damage the tool.

- ▶ Always remove the battery before storing the tool.

- ▶ Store the tool and batteries in a place that is as cool and dry as possible.
- ▶ Never store batteries in direct sunlight, on heating units or behind a window pane.
- ▶ Store the tool and batteries in a place where they cannot be accessed by children or unauthorized persons.
- ▶ Check the tool and batteries for damage before use after long periods of storage.

7.1 Care and maintenance of cordless tools



WARNING

Risk of electric shock! Attempting care and maintenance with the battery fitted in the tool can lead to severe injury and burns.

- ▶ Always remove the battery before carrying out care and maintenance tasks!

Care and maintenance of the tool

- Carefully remove any dirt that may be adhering to parts.
- Clean the air vents carefully with a dry brush.
- Use only a slightly damp cloth to clean the casing. Do not use cleaning agents containing silicone as these may attack the plastic parts.

Care of the lithium-ion batteries

- Keep the battery free from oil and grease.
- Use only a slightly damp cloth to clean the casing. Do not use cleaning agents containing silicone as these may attack the plastic parts.
- Avoid ingress of moisture.

Maintenance

- Check all visible parts and controls for signs of damage at regular intervals and make sure that they all function correctly.
- Do not operate the cordless tool if signs of damage are found or if parts malfunction. Have the tool repaired by **Hilti** Service immediately.
- After cleaning and maintenance, fit all guards or protective devices and check that they function correctly.



Note

To help ensure safe and reliable operation, use only genuine Hilti spare parts and consumables. Spare parts, consumables and accessories approved by Hilti for use with the product can be found at your local **Hilti** Center or online at: www.hilti.com

7.2 Hilti Calibration Service

We recommend that the device is checked by the Hilti calibration service at regular intervals in order to verify its reliability in accordance with standards and legal requirements. Use can be made of the Hilti calibration service at any time, but checking at least once a year is recommended. The calibration service provides confirmation that the device is in conformance, on the day it is tested, with the specifications given in the

operating instructions. After checking, a calibration sticker applied to the device and a calibration certificate provide written verification that the device is operating in accordance with the manufacturer's specification. Calibration certificates are always required by companies certified according to ISO 900x. Your local Hilti Center or representative will be pleased to provide further information.

8 Disposal



WARNING

Risk of injury. Hazards presented by improper disposal.

- ▶ Improper disposal of the equipment may have the following consequences: The burning of plastic components generates toxic fumes which may present a health hazard. Batteries may explode if damaged or exposed to very high temperatures, causing poisoning, burns, acid burns or environmental pollution. Careless disposal may permit unauthorized and improper use of the equipment. This may result in serious personal injury, injury to third parties and pollution of the environment.
- ▶ Dispose of defective batteries right away. Keep them out of reach of children. Do not disassemble or incinerate the batteries.
- ▶ Batteries that have reached the end of their life must be disposed of in accordance with national regulations or returned to **Hilti**.

 Most of the materials from which **Hilti** tools and appliances are manufactured can be recycled. The materials must be correctly separated before they can be recycled. In many countries, your old tools, machines or appliances can be returned to **Hilti** for recycling. Ask **Hilti** Service or your Hilti representative for further information.

9 Manufacturer's warranty

- ▶ Please contact your local **Hilti** representative if you have questions about the warranty conditions.



Hilti Corporation

LI-9494 Schaan

Tel.: +423/234 21 11

Fax: +423/234 29 65

www.hilti.com

Hilti = registered trademark of Hilti Corp., Schaan



20161019